

# DH-IPC-HFW8232E-ZE

## 2MP Starlight IR Bullet Network Camera



### System Overview

Ultra series adopts high performance DSP and Sony advanced image sensor technology, which can provide excellent image effects for users. With Dahua advanced software algorithm, the series is able to support people counting and heat map which brings extra business analysis value for customers. In addition, IP67, IK10 and heater compliance ensure the series can be applied in a harsher environment.

### Functions

#### ePoE technology

The ePoE technology of Dahua, designed internally, adopts advanced 2D-PAM3 coding modulation from physical layer, and realizes full duplex transmission over 800 meters at the speed of 10Mbps, or 300 meters at the speed of 100Mbps via Cat 5 or coaxial cable media. Besides, it supports PoE and PoC power supply technology which has greatly simplified construction and wiring. Dahua ePoE technology offer a new way to accomplish long distance transmission between IP camera and network switch. It allows more flexible surveillance system design, improves reliability and saves construction and wiring cost.

#### Starlight Technology

For challenging low-light applications, Dahua's Starlight Ultra-low Light Technology offers best-in-class light sensitivity, capturing color details in low light down to 0.002lux. The camera uses a set of optical features to balance light throughout the scene, resulting in clear images in dark environments.

#### Wide dynamic range (WDR)

The camera achieves vivid images, even in the most intense contrast lighting conditions, using industry-leading wide dynamic range (WDR) technology. For applications with both bright and low lighting conditions that change quickly, true WDR (120 dB) optimizes both the bright and dark areas of a scene at the same time to provide usable video.

#### Business intelligent analysis (People counting, Heatmap)

Dahua Camera also supports more advanced intelligent features such as

- 1/1.9" 2Megapixel progressive scan CMOS
- H.265&H.264 triple-stream encoding
- 50/60fps@1080P(1920×1080)
- WDR(120dB), Day/Night(ICR), 3DNR,AWB,AGC,BLC
- Multiple network monitoring: Web viewer, CMS(DSS/PSS) & DMSS
- 4.1mm ~16.4mm zoom lens
- Max. IR LEDs Length 50m
- Micro SD memory,IP67,IK10,PoE+



people counting and heat map besides basic IVS functions. These two functions can be applied to business intelligence and bring extra values to customers. It is available to acquire daily, weekly, monthly and yearly people flow via people counting and output data report. Heat map can be based on a moving object in time of space movement for analysis, find the most active area and output the report, which is to provide valuable data support for commercial applications.

#### Smart Scene Adaptive (SSA)

Smart Scene Adaptive (SSA) is an intelligent image technology, developed by Dahua that automatically evaluates and compensates for changes in the luminance of a scene. SSA automatically regulates the exposure parameters to improve image quality in a backlit scene, especially in scenes with traffic lights or headlights.

#### Smart Codec (H.265+ & H.264+)

Smart Codec is the optimized implementation of standard video compression (H.265 & H.264) that uses a scene-adaptive encoding strategy, dynamic GOP, dynamic ROI, flexible multi-frame reference structure and intelligent noise reduction to deliver high-quality video without straining the network. Smart Codec technology reduces bit rate and storage requirements by up to 70% when compared to the standard video compression.

#### Environmental & Protection

With a temperature range of -40 °C to +60 °C (-40 °F to +140 °F), the camera is designed for extreme temperature environments. Supporting ±25% input voltage tolerance, this camera suits even the most unstable conditions for outdoor applications. Its 6KV lightning rating provides effective protection for both the camera and its structure against lightning. Subjected and certified to rigorous dust and immersion tests (IP67) and impact tests (IK10), The camera complies with an IK10 impact rating making it capable of withstanding the equivalent of 5 kg (11.02 lbs) of force dropped from a height of 40 cm (15.75 in.)

Technical Specification						
Camera						
Image Sensor	1/1.9" 2Megapixel progressive scan CMOS					
Effective Pixels	1920(H)x1080(V)					
RAM/ROM	1024MB/128MB					
Scanning System	Progressive					
Electronic Shutter Speed	Auto/Manual, 1/3~1/100000s					
Minimum Illumination	0.002Lux/F1.53 (Color,1/3s,30IRE) 0.01Lux/F1.53 (Color,1/30s,30IRE) 0Lux/F1.53(IR on)					
S/N Ratio	More than 50dB					
IR Distance	Distance up to 50m(164ft)					
IR On/Off Control	Auto/ Manual					
IR LEDs	4					
Lens						
Lens Type	Motorized /Auto Iris(HALL)					
Mount Type	Board-in					
Focal Length	4.1~16.4mm motorized					
Max. Aperture	F1.53					
Angle of View	H: 104°~33 ° V:57 ° ~18 °					
Optical Zoom	4x					
Focus Control	Motorized					
Predictive Focus Algorithm (PFA)	Support					
Close Focus Distance	0.5m(1.64ft)					
DORI Distance	Lens	Detect	Observe	Recognize	Identify	
	W	57m(187ft)	23m(75ft)	11m(36ft)	6m(20ft)	
	T	137m(449ft)	55m(180ft)	27m(89ft)	14m(49ft)	
Pan/Tilt/Rotation						
Pan/Tilt/Rotation Range	Pan:0°~360°; Tilt:0°~90°; Rotation:0°~360°					
Intelligence						
Event Trigger	Motion detection, Video tampering , Scene changing, Network disconnection , IP address conflict, Illegal Access,Storage anomaly					
IVS	Tripwire, Intrusion, Object Abandoned/Missing					
Advanced Intelligent Functions	Face Detection, People Counting, Heat Map					
Video						
Compression	H.265/H.264/H.264B/H.264H/MJPEG(Sub Stream)					
Smart Codec	Support H.265+/H.264+					
Streaming Capability	3 Streams					
Resolution	1080P(1920x1080)/ 1.3M(1280x960)/ 720P(1280x720)/ D1(704x576/704x480) / VGA(640x480)/ CIF(352x288/342x240)					
Frame Rate	Main Stream: 1080P(1~50/60fps)					
	Sub Stream: D1 (1 ~ 50/60fps)					
	Third Stream: 1080P(1~50/60fps)					
Bit Rate Control	CBR/VBR					
Bit Rate	H.264: 24~ 10240Kbps H.265: 14~ 6144Kbps					
Day/Night	Auto(ICR) / Color / B/W					
BLC Mode	BLC / HLC / WDR(120dB)/ SSA					
White Balance	Auto/Natural/Street Lamp/Outdoor/Manual					
Gain Control	Auto/Manual					
Noise Reduction	3D DNR					
Motion Detection	Off / On (4 Zone, Rectangle)					
Region of Interest	Off / On (4 Zone)					
Electronic Image Stabilization (EIS)	Support					
Smart IR	Support					
Defog	Support					
Digital Zoom	16x					
Flip	0°/90°/180°/270°					
Mirror	Off / On					
Privacy Masking	Off / On (4 Area, Rectangle)					
Audio						
Compression	G.711a/G.711Mu/AAC/ G.726					
Network						
Ethernet	RJ-45 (100/1000Base-T)					
Protocol	HTTP;HTTPS;TCP;ARP;RTSP;RTP;UDP;RTCP;SMTP; FTP;DHCP;DNS;DDNS;PPPOE;IPv4/v6;QoS;UPnP; NTP;Bonjour;IEEE 802.1x;Multicast;ICMP;IGMP;S NMP;TLS					
Interoperability	ONVIF Profile S&G, API					
Streaming Method	Unicast / Multicast					
Max. User Access	10 Users/20 Users					
Edge Storage	NAS Local PC for instant recording Mirco SD card 128GB					
Web Viewer	IE, Chrome, Firefox, Safari					
Management Software	Smart PSS, DSS, DMSS					
Smart Phone	IOS, Android					
Certifications						
Certifications	CE (EN 60950:2000) UL:UL60950-1 FCC: FCC Part 15 Subpart B					
Interface						
Video Interface	1 Port(For adjustment only)					
Audio Interface	1/1 channel In/Out					
RS485	N/A					
Alarm	2 channel In: 5mA 5VDC 1 channel Out: 1A 30VDC / 0.5A 50VAC					

Electrical

Power Supply	DC12V, PoE+(802.3at)(Class 4)
Power Consumption	<13W

Environmental

Operating Conditions	-40° C ~ +60° C (-40° F ~ +140° F) / Less than 95% RH
Storage Conditions	-40° C ~ +60° C (-40° F ~ +140° F) / Less than 95% RH
Ingress Protection	IP67
Vandal Resistance	IK10

Construction

Casing	Metal
Dimensions	273.2mm×95.0mm×95.0mm (10.76"×3.74"×3.74")
Net Weight	1.12Kg (2.47lb)
Gross Weight	1.52Kg (3.35lb)

Ordering Information

Type	Part Number	Description
2MP camera	DH-IPC-HFW8232EP-ZE	2MP Starlight IR Bullet Network Camera,PAL
	DH-IPC-HFW8232EN-ZE	2MP Starlight IR Bullet Network Camera,NTSC
	IPC-HFW8232EP-ZE	2MP Starlight IR Bullet Network Camera,PAL
	IPC-HFW8232EN-ZE	2MP Starlight IR Bullet Network Camera,NTSC
Accessories (optional)	PFA121	Junction box
	PFA152-E	Pole Mount
	LR1002	ePoE Over Coax Converter

Accessories

Optional:



PFA121  
Junction box



PFA152-E  
Pole Mount



LR1002  
ePoE Over Coax Converter

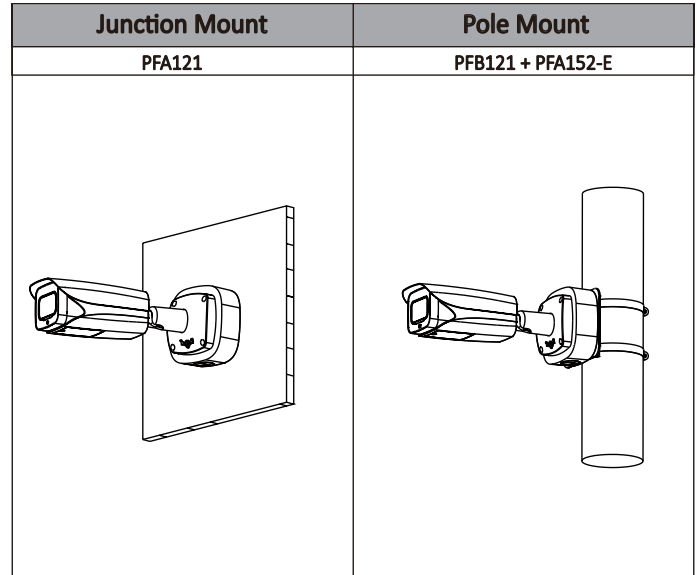

Dimensions (mm/inch)

